

KBAS121400 12V 140Ah



The Kaise Solar Range is mainly used in renewable energy applications, due to its optimal cyclic use performance. It is specially designed for frequent cyclic charge and discharging, providing superior high integrity and reliability. By using strong grids, thick plate and specially active material are designed for repeated deep-discharge applications. Kaise Solar Range offer approx. 30% more cyclic life than the Standard Series.



Performance Characteristics

Nominal Voltage	12V	
Dimensions	Length (mm / inch)	407±2 / 16.0
	Width (mm / inch)	177±2 / 6.97
	Height (mm / inch)	225±2 / 8.86
	Total Height (mm / inch)	225±2 / 8.86
Approx. Weight	(Kg / lbs) 33.5 / 73.9	
Design Life	12 years (floating charge)	
Terminal	M8	
Container Material	A.B.S. UL94-HB, UL94-V0 Optional.	
Rated Capacity	139.8 Ah / 1.398 A	100hr, 1.60V/c, 25°C / 77°F
	115.4 Ah / 11.54 A	(10hr, 1.75V/c, 25°C / 77°F)
	70.40 Ah / 70.40 A	(1hr, 1.65V/c, 25°C / 77°F)
Max. Discharge Current	1200A (5s)	
Internal Resistance	Approx 4.5mΩ	
Operating Temp. Range	Discharge : -20 ~ 60°C	
	Charge : 0 ~ 50°C	
	Storage : -20 ~ 60°C	
Nominal Operating Temp. Range	25°C ± 5°C	
Cycle Use	Voltage: 14.6V ~ 14.8V at 25°C (77°F)	
	Temp. Compensation: -4mV/°C / Cell	
Float Voltage Use	Voltage: 13.6V ~ 13.8V at 25°C (77°F)	
	Temp. Compensation: -3mV/°C / Cell	
Capacity affected by Temperature	40°C (104°F)	103%
	25°C (77°F)	100%
	0°C (32°F)	86%
Self Discharge	Fully charged Kaise Solar Series batteries may be stored for up to 6 months at 25°C (77°F) and then a freshening charge is required. For higher temperatures the time interval will be shorter.	

Constant Current Discharge (Amperes) at 25°C (77°F)

Volts/cell	1h	3h	4h	8h	10h	24h	100h
1.80V	63.07	30.00	23.69	13.67	11.43	5.024	1.331
1.75V	66.00	30.58	24.25	13.90	11.54	5.074	1.345
1.70V	68.14	31.38	24.93	14.13	11.66	5.124	1.358
1.65V	70.40	32.77	25.73	14.36	11.89	5.225	1.385
1.60V	72.88	33.81	26.52	14.47	12.00	5.275	1.398

Dimensions and Terminal (Unit: mm (inches))

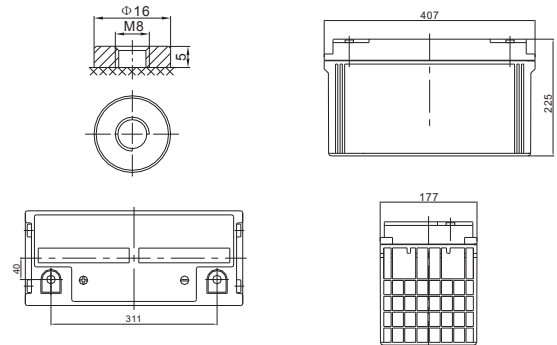

Applications

- Renewable Energy
- Pump Systems
- Traffic lights
- Street lightening
- Marine equipment
- Caravans & Boats
- Weekend cottage camping
- Telecommunications systems

Certifications

ISO 9001:2008 ISO 14001:2008



Discharge Current vs. Discharge Voltage

Final discharge voltage V/CELL	1.8	1.75	1.7	1.6
Discharge current (A)	I ≤ 0.1CA	0.25CA ≥ I > 0.1CA	0.55CA ≥ I > 0.25CA	I > 0.55CA

Constant Power Discharge (Watts per cell) at 25°C (77°F)

Volts/cell	1h	3h	4h	8h	10h	24h	100h
1.80V	121.7	58.38	46.24	26.73	22.40	9.848	2.610
1.75V	126.9	58.71	47.15	27.18	22.63	9.947	2.636
1.70V	130.5	60.20	48.28	27.63	22.85	10.05	2.663
1.65V	134.5	62.60	49.87	27.97	23.31	10.25	2.715
1.60V	136.8	64.20	51.11	28.20	23.53	10.35	2.742

(Note) The above characteristics data are average values obtained within three charge/discharge cycles not the minimum values.

Discharge Characteristics Curve

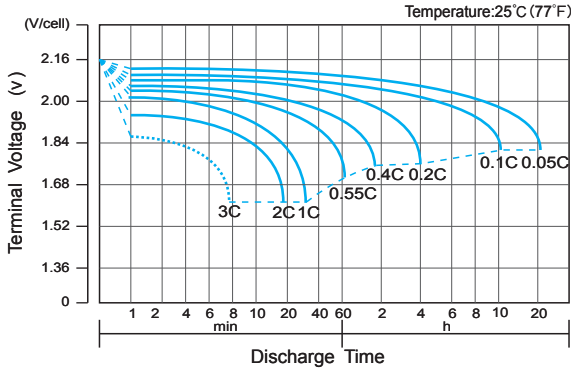

Charge Characteristic Curve for Cycle Use (IU)

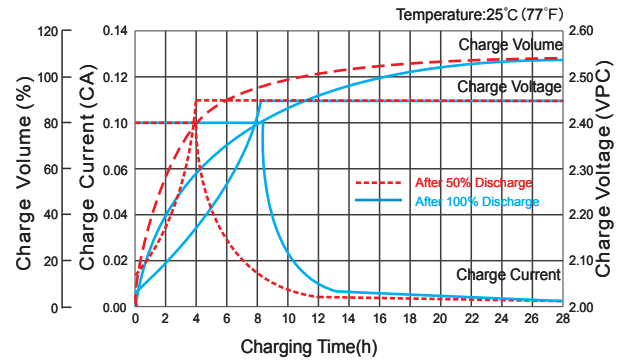

Cycle Life in Relation to Depth of Discharge

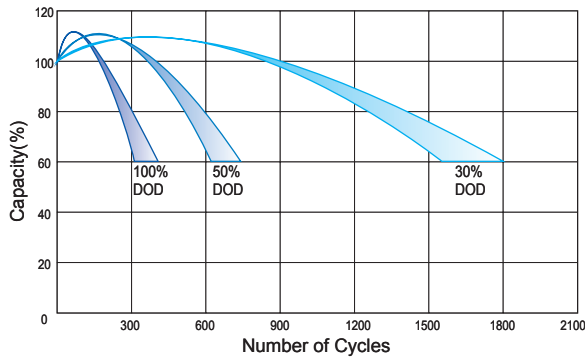

Relation between Charging Voltage and Temperature

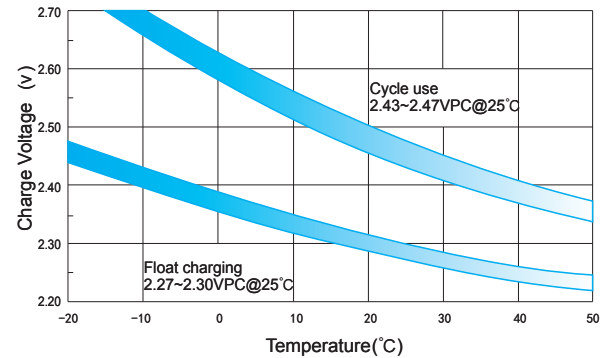

Temperature Effects on Capacity

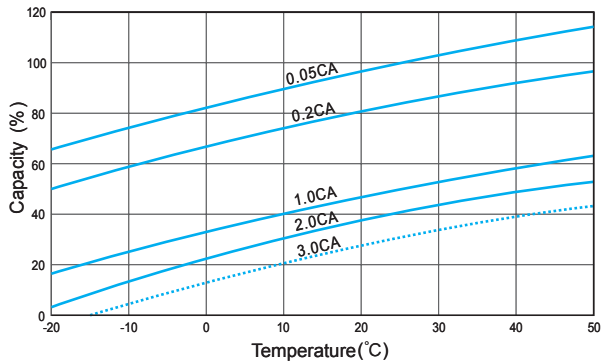

Storage Characteristics

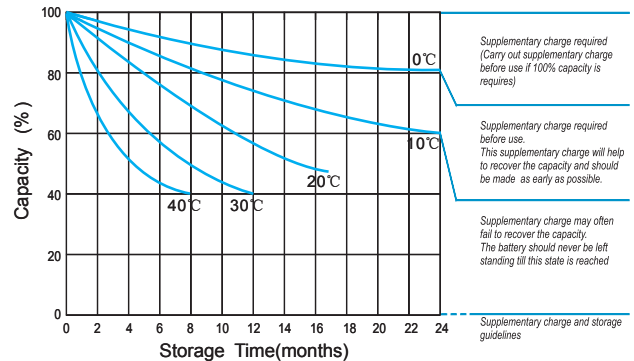

Effect of Temperature on Long Term Life

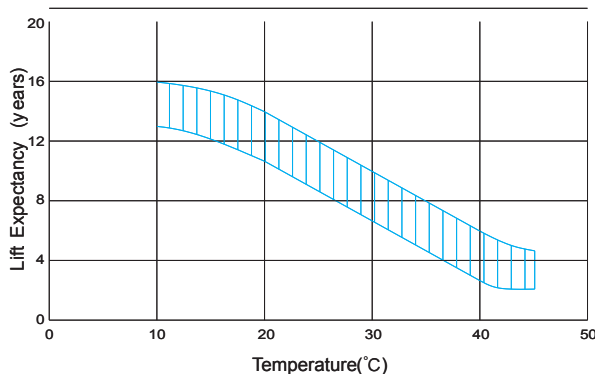

Relation between OCV and State of Charge (20°C)

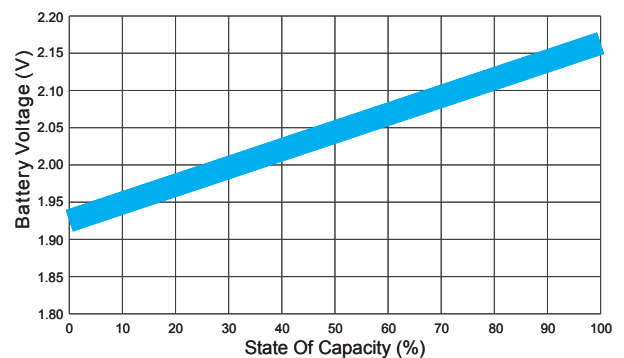

IMPORTANT NOTE: The specifications presented herein are subject to revision without notice.

